

SAMPLE HOUSE PLANS

phone: 123.456.7891

sample.com



NO.	DESCRIPTION	QTY	UNIT	PRICE	TOTAL
1	FOUNDATION				
2	FLOORING				
3	CEILING				
4	WALLS				
5	ROOFING				
6	PAINT				
7	DOORS				
8	WINDOWS				
9	PLUMBING				
10	ELECTRICAL				
11	MECHANICAL				
12	LANDSCAPE				
13	PERMITS				
14	INSULATION				
15	STAIRS				
16	BATHS				
17	KITCHEN				
18	BREAKFAST ROOM				
19	LIVING ROOM				
20	DINING ROOM				
21	BEDROOM				
22	BEDROOM				
23	BEDROOM				
24	BEDROOM				
25	BEDROOM				
26	BEDROOM				
27	BEDROOM				
28	BEDROOM				
29	BEDROOM				
30	BEDROOM				
31	BEDROOM				
32	BEDROOM				
33	BEDROOM				
34	BEDROOM				
35	BEDROOM				
36	BEDROOM				
37	BEDROOM				
38	BEDROOM				
39	BEDROOM				
40	BEDROOM				

NO.	DESCRIPTION	QTY	UNIT	PRICE	TOTAL
1	FOUNDATION				
2	FLOORING				
3	CEILING				
4	WALLS				
5	ROOFING				
6	PAINT				
7	DOORS				
8	WINDOWS				
9	PLUMBING				
10	ELECTRICAL				
11	MECHANICAL				
12	LANDSCAPE				
13	PERMITS				
14	INSULATION				
15	STAIRS				
16	BATHS				
17	KITCHEN				
18	BREAKFAST ROOM				
19	LIVING ROOM				
20	DINING ROOM				
21	BEDROOM				
22	BEDROOM				
23	BEDROOM				
24	BEDROOM				
25	BEDROOM				
26	BEDROOM				
27	BEDROOM				
28	BEDROOM				
29	BEDROOM				
30	BEDROOM				
31	BEDROOM				
32	BEDROOM				
33	BEDROOM				
34	BEDROOM				
35	BEDROOM				
36	BEDROOM				
37	BEDROOM				
38	BEDROOM				
39	BEDROOM				
40	BEDROOM				

NO.	DESCRIPTION	QTY	UNIT	PRICE	TOTAL
1	FOUNDATION				
2	FLOORING				
3	CEILING				
4	WALLS				
5	ROOFING				
6	PAINT				
7	DOORS				
8	WINDOWS				
9	PLUMBING				
10	ELECTRICAL				
11	MECHANICAL				
12	LANDSCAPE				
13	PERMITS				
14	INSULATION				
15	STAIRS				
16	BATHS				
17	KITCHEN				
18	BREAKFAST ROOM				
19	LIVING ROOM				
20	DINING ROOM				
21	BEDROOM				
22	BEDROOM				
23	BEDROOM				
24	BEDROOM				
25	BEDROOM				
26	BEDROOM				
27	BEDROOM				
28	BEDROOM				
29	BEDROOM				
30	BEDROOM				
31	BEDROOM				
32	BEDROOM				
33	BEDROOM				
34	BEDROOM				
35	BEDROOM				
36	BEDROOM				
37	BEDROOM				
38	BEDROOM				
39	BEDROOM				
40	BEDROOM				

NOT FOR CONSTRUCTION

NOT FOR CONSTRUCTION

Mark Rivers

SAMPLE HOUSE PLANS

phone: 123.456.7891

sample.com



LOWER LEVEL ELECTRICAL LAYOUT

NOT FOR CONSTRUCTION

ELECTRICAL LEGEND			
[Symbol]	120V AC	[Symbol]	120V AC
[Symbol]	240V AC	[Symbol]	240V AC
[Symbol]	3-Phase	[Symbol]	3-Phase
[Symbol]	4-Phase	[Symbol]	4-Phase
[Symbol]	5-Phase	[Symbol]	5-Phase
[Symbol]	6-Phase	[Symbol]	6-Phase
[Symbol]	7-Phase	[Symbol]	7-Phase
[Symbol]	8-Phase	[Symbol]	8-Phase
[Symbol]	9-Phase	[Symbol]	9-Phase
[Symbol]	10-Phase	[Symbol]	10-Phase
[Symbol]	11-Phase	[Symbol]	11-Phase
[Symbol]	12-Phase	[Symbol]	12-Phase
[Symbol]	13-Phase	[Symbol]	13-Phase
[Symbol]	14-Phase	[Symbol]	14-Phase
[Symbol]	15-Phase	[Symbol]	15-Phase
[Symbol]	16-Phase	[Symbol]	16-Phase
[Symbol]	17-Phase	[Symbol]	17-Phase
[Symbol]	18-Phase	[Symbol]	18-Phase
[Symbol]	19-Phase	[Symbol]	19-Phase
[Symbol]	20-Phase	[Symbol]	20-Phase
[Symbol]	21-Phase	[Symbol]	21-Phase
[Symbol]	22-Phase	[Symbol]	22-Phase
[Symbol]	23-Phase	[Symbol]	23-Phase
[Symbol]	24-Phase	[Symbol]	24-Phase
[Symbol]	25-Phase	[Symbol]	25-Phase
[Symbol]	26-Phase	[Symbol]	26-Phase
[Symbol]	27-Phase	[Symbol]	27-Phase
[Symbol]	28-Phase	[Symbol]	28-Phase
[Symbol]	29-Phase	[Symbol]	29-Phase
[Symbol]	30-Phase	[Symbol]	30-Phase

- 120V AC
- 240V AC
- 3-Phase
- 4-Phase
- 5-Phase
- 6-Phase
- 7-Phase
- 8-Phase
- 9-Phase
- 10-Phase
- 11-Phase
- 12-Phase
- 13-Phase
- 14-Phase
- 15-Phase
- 16-Phase
- 17-Phase
- 18-Phase
- 19-Phase
- 20-Phase
- 21-Phase
- 22-Phase
- 23-Phase
- 24-Phase
- 25-Phase
- 26-Phase
- 27-Phase
- 28-Phase
- 29-Phase
- 30-Phase

NOTE: LOCATION OF EQUIPMENT, INCLUDING DATA SHEETS AND FLUOR RECEPTACLES TO BE INSTALLED BY OWNER, NOT SHOWN HERE AND SHOULD BE OBTAINED FROM OWNER'S ARCHITECTURAL PLAN.

KEN PIERER

ELECTRICAL LEGEND			
1	11-120V RECEPT	2	21-RECEPT
2	11-120V RECEPT	3	22-RECEPT
3	11-120V RECEPT	4	23-RECEPT
4	11-120V RECEPT	5	24-RECEPT
5	11-120V RECEPT	6	25-RECEPT
6	11-120V RECEPT	7	26-RECEPT
7	11-120V RECEPT	8	27-RECEPT
8	11-120V RECEPT	9	28-RECEPT
9	11-120V RECEPT	10	29-RECEPT
10	11-120V RECEPT	11	30-RECEPT
11	11-120V RECEPT	12	31-RECEPT
12	11-120V RECEPT	13	32-RECEPT
13	11-120V RECEPT	14	33-RECEPT
14	11-120V RECEPT	15	34-RECEPT
15	11-120V RECEPT	16	35-RECEPT
16	11-120V RECEPT	17	36-RECEPT
17	11-120V RECEPT	18	37-RECEPT
18	11-120V RECEPT	19	38-RECEPT
19	11-120V RECEPT	20	39-RECEPT
20	11-120V RECEPT	21	40-RECEPT
21	11-120V RECEPT	22	41-RECEPT
22	11-120V RECEPT	23	42-RECEPT
23	11-120V RECEPT	24	43-RECEPT
24	11-120V RECEPT	25	44-RECEPT
25	11-120V RECEPT	26	45-RECEPT
26	11-120V RECEPT	27	46-RECEPT
27	11-120V RECEPT	28	47-RECEPT
28	11-120V RECEPT	29	48-RECEPT
29	11-120V RECEPT	30	49-RECEPT
30	11-120V RECEPT	31	50-RECEPT
31	11-120V RECEPT	32	51-RECEPT
32	11-120V RECEPT	33	52-RECEPT
33	11-120V RECEPT	34	53-RECEPT
34	11-120V RECEPT	35	54-RECEPT
35	11-120V RECEPT	36	55-RECEPT
36	11-120V RECEPT	37	56-RECEPT
37	11-120V RECEPT	38	57-RECEPT
38	11-120V RECEPT	39	58-RECEPT
39	11-120V RECEPT	40	59-RECEPT
40	11-120V RECEPT	41	60-RECEPT
41	11-120V RECEPT	42	61-RECEPT
42	11-120V RECEPT	43	62-RECEPT
43	11-120V RECEPT	44	63-RECEPT
44	11-120V RECEPT	45	64-RECEPT
45	11-120V RECEPT	46	65-RECEPT
46	11-120V RECEPT	47	66-RECEPT
47	11-120V RECEPT	48	67-RECEPT
48	11-120V RECEPT	49	68-RECEPT
49	11-120V RECEPT	50	69-RECEPT
50	11-120V RECEPT	51	70-RECEPT
51	11-120V RECEPT	52	71-RECEPT
52	11-120V RECEPT	53	72-RECEPT
53	11-120V RECEPT	54	73-RECEPT
54	11-120V RECEPT	55	74-RECEPT
55	11-120V RECEPT	56	75-RECEPT
56	11-120V RECEPT	57	76-RECEPT
57	11-120V RECEPT	58	77-RECEPT
58	11-120V RECEPT	59	78-RECEPT
59	11-120V RECEPT	60	79-RECEPT
60	11-120V RECEPT	61	80-RECEPT
61	11-120V RECEPT	62	81-RECEPT
62	11-120V RECEPT	63	82-RECEPT
63	11-120V RECEPT	64	83-RECEPT
64	11-120V RECEPT	65	84-RECEPT
65	11-120V RECEPT	66	85-RECEPT
66	11-120V RECEPT	67	86-RECEPT
67	11-120V RECEPT	68	87-RECEPT
68	11-120V RECEPT	69	88-RECEPT
69	11-120V RECEPT	70	89-RECEPT
70	11-120V RECEPT	71	90-RECEPT
71	11-120V RECEPT	72	91-RECEPT
72	11-120V RECEPT	73	92-RECEPT
73	11-120V RECEPT	74	93-RECEPT
74	11-120V RECEPT	75	94-RECEPT
75	11-120V RECEPT	76	95-RECEPT
76	11-120V RECEPT	77	96-RECEPT
77	11-120V RECEPT	78	97-RECEPT
78	11-120V RECEPT	79	98-RECEPT
79	11-120V RECEPT	80	99-RECEPT
80	11-120V RECEPT	81	100-RECEPT

SAMPLE HOUSE PLANS
 phone: 123.456.7891
 sample.com

NOTES:
 1. ALL WORK SHALL BE IN ACCORDANCE WITH THE NATIONAL ELECTRICAL CODE (NEC) AND THE NATIONAL FIRE ALARM AND SIGNAL CODE (NFPA 72).
 2. ALL WORK SHALL BE IN ACCORDANCE WITH THE NATIONAL ELECTRICAL CODE (NEC) AND THE NATIONAL FIRE ALARM AND SIGNAL CODE (NFPA 72).
 3. ALL WORK SHALL BE IN ACCORDANCE WITH THE NATIONAL ELECTRICAL CODE (NEC) AND THE NATIONAL FIRE ALARM AND SIGNAL CODE (NFPA 72).
 4. ALL WORK SHALL BE IN ACCORDANCE WITH THE NATIONAL ELECTRICAL CODE (NEC) AND THE NATIONAL FIRE ALARM AND SIGNAL CODE (NFPA 72).
 5. ALL WORK SHALL BE IN ACCORDANCE WITH THE NATIONAL ELECTRICAL CODE (NEC) AND THE NATIONAL FIRE ALARM AND SIGNAL CODE (NFPA 72).
 6. ALL WORK SHALL BE IN ACCORDANCE WITH THE NATIONAL ELECTRICAL CODE (NEC) AND THE NATIONAL FIRE ALARM AND SIGNAL CODE (NFPA 72).
 7. ALL WORK SHALL BE IN ACCORDANCE WITH THE NATIONAL ELECTRICAL CODE (NEC) AND THE NATIONAL FIRE ALARM AND SIGNAL CODE (NFPA 72).
 8. ALL WORK SHALL BE IN ACCORDANCE WITH THE NATIONAL ELECTRICAL CODE (NEC) AND THE NATIONAL FIRE ALARM AND SIGNAL CODE (NFPA 72).
 9. ALL WORK SHALL BE IN ACCORDANCE WITH THE NATIONAL ELECTRICAL CODE (NEC) AND THE NATIONAL FIRE ALARM AND SIGNAL CODE (NFPA 72).
 10. ALL WORK SHALL BE IN ACCORDANCE WITH THE NATIONAL ELECTRICAL CODE (NEC) AND THE NATIONAL FIRE ALARM AND SIGNAL CODE (NFPA 72).



MAIN LEVEL ELECTRICAL LAYOUT

SAMPLE HOUSE PLANS
phone: 123.456.7891
sample.com

ELECTRICAL LEGEND		
[Symbol]	15 AMP	15 AMP
[Symbol]	20 AMP	20 AMP
[Symbol]	30 AMP	30 AMP
[Symbol]	40 AMP	40 AMP
[Symbol]	50 AMP	50 AMP
[Symbol]	60 AMP	60 AMP
[Symbol]	70 AMP	70 AMP
[Symbol]	80 AMP	80 AMP
[Symbol]	90 AMP	90 AMP
[Symbol]	100 AMP	100 AMP
[Symbol]	110 AMP	110 AMP
[Symbol]	120 AMP	120 AMP
[Symbol]	130 AMP	130 AMP
[Symbol]	140 AMP	140 AMP
[Symbol]	150 AMP	150 AMP
[Symbol]	160 AMP	160 AMP
[Symbol]	170 AMP	170 AMP
[Symbol]	180 AMP	180 AMP
[Symbol]	190 AMP	190 AMP
[Symbol]	200 AMP	200 AMP

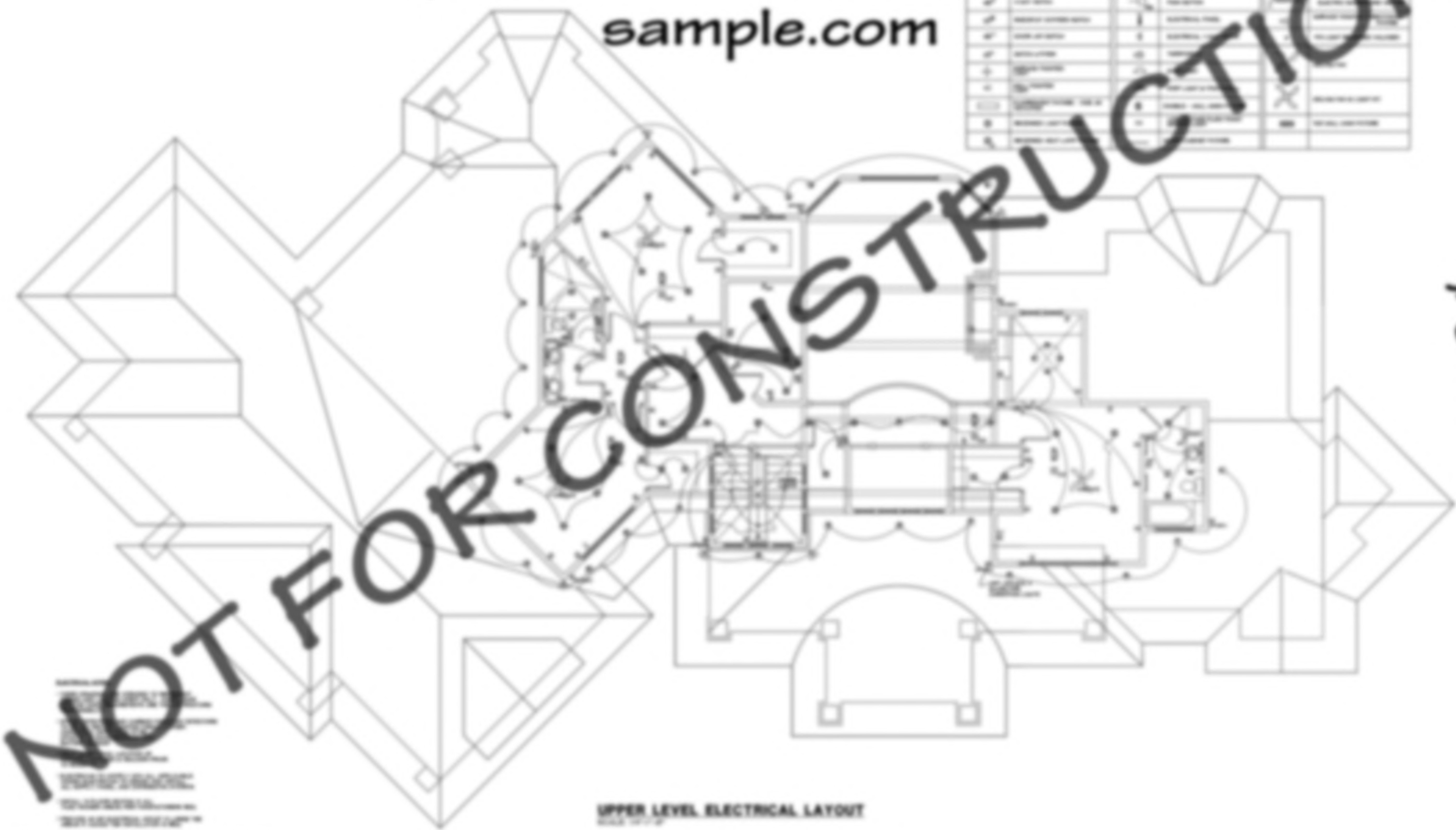

UPPER LEVEL ELECTRICAL LAYOUT

NOT FOR CONSTRUCTION

VERAFLEX

VERAFLEX

VERAFLEX

VERAFLEX

VERAFLEX

NOTE: LOCATION OF ELECTRICAL SYMBOLS SHOWN ON THIS PLAN AND FLOOR RELOCATIONS TO BE ADDED BY OWNER. NOT ALL SYMBOLS ARE SHOWN. ONLY THOSE SHOWN IN THE LARGE SCALE PLAN.

KEN RIEBER

SAMPLE HOUSE PLANS

phone: 123.456.7891

sample.com

SAMPLE PLAN



FRONT ELEVATION

NOT FOR CONSTRUCTION

Ken Rieper

- ELEVATION NOTES**
1. SEE FLOOR PLAN FOR WALLS
 2. SEE FLOOR PLAN FOR ROOF
 3. SEE FLOOR PLAN FOR WINDOWS
 4. SEE FLOOR PLAN FOR DOORS
 5. SEE FLOOR PLAN FOR PORCHES
 6. SEE FLOOR PLAN FOR PATIOS
 7. SEE FLOOR PLAN FOR DECKS
 8. SEE FLOOR PLAN FOR STAIRS
 9. SEE FLOOR PLAN FOR BALCONIES
 10. SEE FLOOR PLAN FOR TERRACES
 11. SEE FLOOR PLAN FOR DRIVEWAYS
 12. SEE FLOOR PLAN FOR GARAGES
 13. SEE FLOOR PLAN FOR PORCHES
 14. SEE FLOOR PLAN FOR PATIOS
 15. SEE FLOOR PLAN FOR DECKS
 16. SEE FLOOR PLAN FOR STAIRS
 17. SEE FLOOR PLAN FOR BALCONIES
 18. SEE FLOOR PLAN FOR TERRACES
 19. SEE FLOOR PLAN FOR DRIVEWAYS
 20. SEE FLOOR PLAN FOR GARAGES



RIGHT ELEVATION

SAMPLE HOUSE PLANS

phone: 123.456.7891

sample.com

SAMPLE PLAN



REAR ELEVATION



LEFT ELEVATION

- EXPLANATIONS**
- 1. SEE EXPLANATIONS SHEET
 - 2. SEE EXPLANATIONS SHEET
 - 3. SEE EXPLANATIONS SHEET
 - 4. SEE EXPLANATIONS SHEET
 - 5. SEE EXPLANATIONS SHEET
 - 6. SEE EXPLANATIONS SHEET
 - 7. SEE EXPLANATIONS SHEET
 - 8. SEE EXPLANATIONS SHEET
 - 9. SEE EXPLANATIONS SHEET
 - 10. SEE EXPLANATIONS SHEET
 - 11. SEE EXPLANATIONS SHEET
 - 12. SEE EXPLANATIONS SHEET
 - 13. SEE EXPLANATIONS SHEET
 - 14. SEE EXPLANATIONS SHEET
 - 15. SEE EXPLANATIONS SHEET
 - 16. SEE EXPLANATIONS SHEET
 - 17. SEE EXPLANATIONS SHEET
 - 18. SEE EXPLANATIONS SHEET
 - 19. SEE EXPLANATIONS SHEET
 - 20. SEE EXPLANATIONS SHEET

NOT FOR CONSTRUCTION

KEN RIEBER

SAMPLE HOUSE PLANS

phone: 123.456.7891

sample.com

NOT FOR CONSTRUCTION

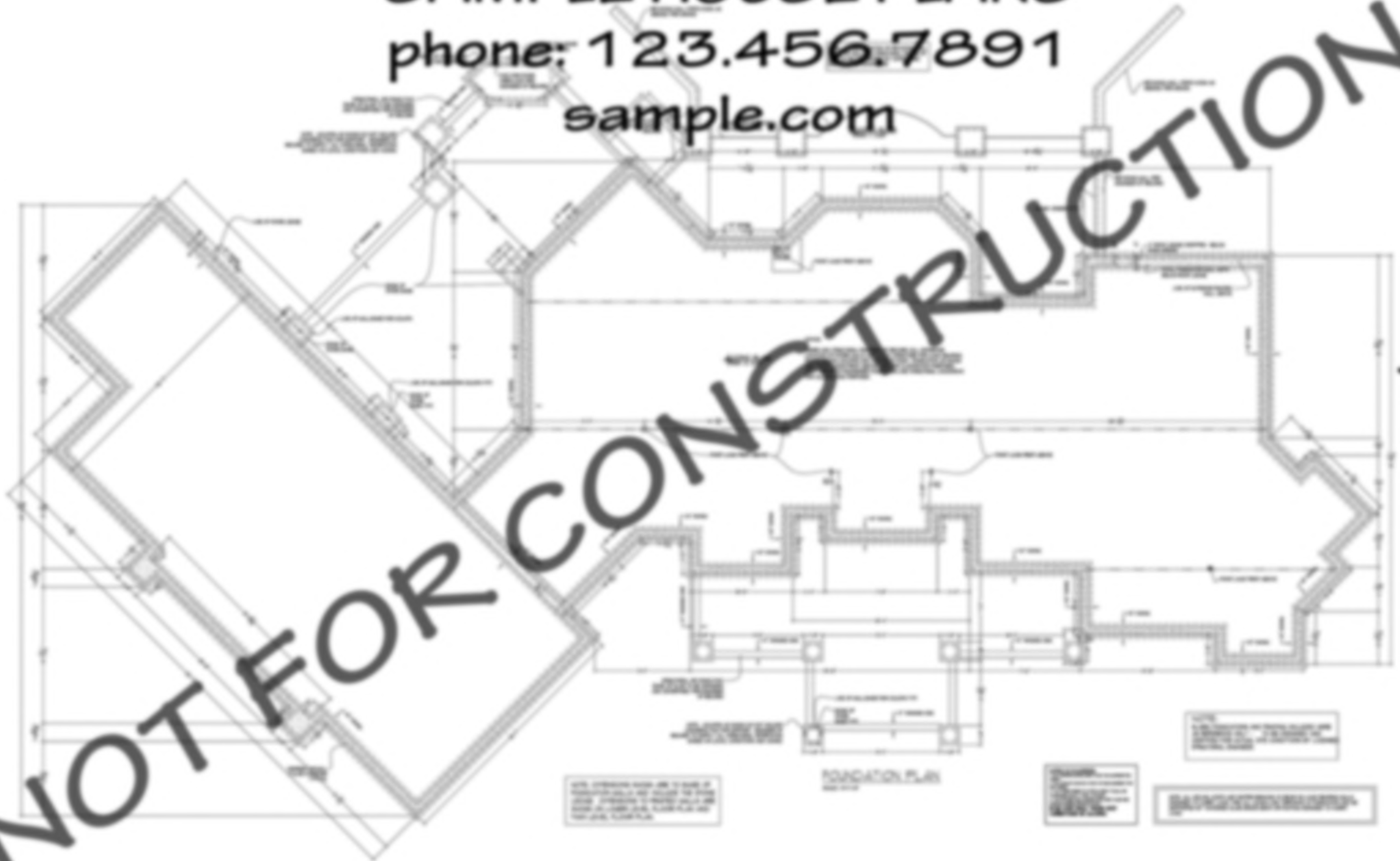

SAMPLE PLAN

KEN PIERER

SAMPLE HOUSE PLANS

phone: 123.456.7891

sample.com

NOT FOR CONSTRUCTION



FIRST LEVEL FLOOR FINISH PLAN

KEN PIERER

SAMPLE HOUSE PLANS

phone: 123.456.7891

sample.com

NOT FOR CONSTRUCTION



UPPER LEVEL FLOOR FINISH PLAN

KEN PIERER

SAMPLE HOUSE PLANS

phone: 123.456.7891

sample.com

SAMPLE PLAN

NOT FOR CONSTRUCTION

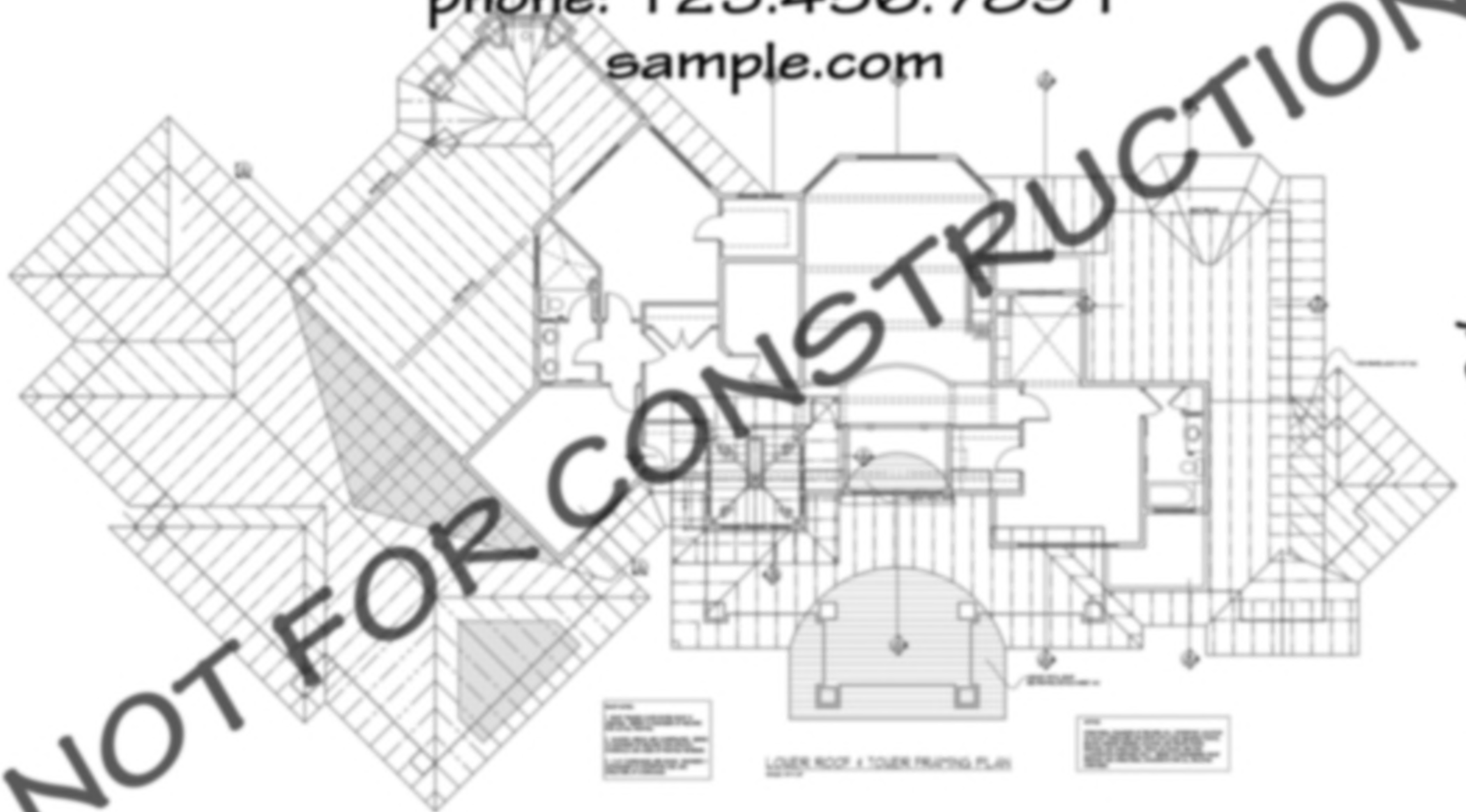

1. ALL ROOMS
 2. ALL ROOMS
 3. ALL ROOMS

LOWER FLOOR & TOWER FINISHING PLAN

1. ALL ROOMS
 2. ALL ROOMS
 3. ALL ROOMS

KEN PIERER

SAMPLE HOUSE PLANS

phone: 123.456.7891

sample.com



NOT FOR CONSTRUCTION

UPPER ROOF TRUSS PLAN

KEN PIERER

SAMPLE HOUSE PLANS

phone: 123.456.7891

sample.com

NOT FOR CONSTRUCTION

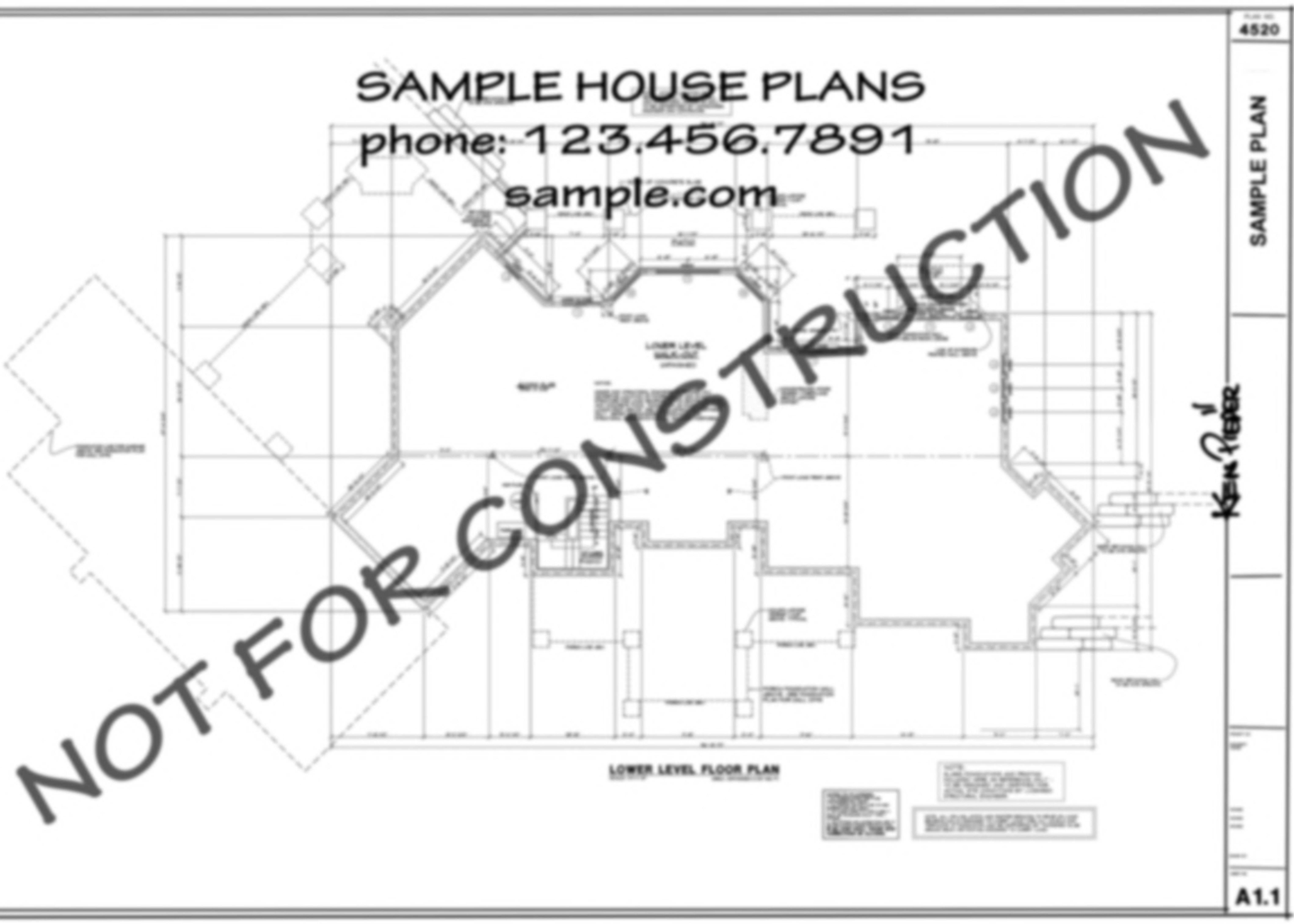

LOWER LEVEL FLOOR PLAN

- 1. WALLS
- 2. DOORS
- 3. WINDOWS
- 4. STAIRS
- 5. ELEVATIONS
- 6. FINISHES
- 7. STRUCTURE
- 8. MECHANICAL
- 9. ELECTRICAL
- 10. PLUMBING

SAMPLE PLAN

Ken Pifer

SAMPLE HOUSE PLANS

phone: 123.456.7891

sample.com

PROJECT NO. 4520
 DATE: 12/15/2023
 DRAWN BY: J. SMITH
 CHECKED BY: M. JONES
 SCALE: 1/8" = 1'-0"
 SHEET NO. A1.2



ALL DIMENSIONS
 TO UNLESS
 OTHERWISE
 SPECIFIED
 SHALL BE IN
 FEET AND INCHES
 FRACTIONS SHALL BE
 IN 16THS OF AN INCH
 FINISH SURF TO FINISH SURF
 UNLESS OTHERWISE NOTED
 DIMENSIONS TO FACE UNLESS NOTED
 DIMENSIONS TO CENTER UNLESS NOTED

SAMPLE PLAN

KEN PIERER

SAMPLE HOUSE PLANS

phone: 123.456.7891

sample.com



ROOF OVERVIEW PLAN

1/2\"/>1/4\"/>

KEN PIERER

DOOR SCHEDULE		
NO.	DESCRIPTION	MARK
1	6'0" x 2'0" Solid Core	101
2	6'0" x 2'0" Hollow Core	102
3	6'0" x 2'0" Glass	103
4	6'0" x 2'0" Sliding Glass	104
5	6'0" x 2'0" Sliding Glass	105
6	6'0" x 2'0" Sliding Glass	106
7	6'0" x 2'0" Sliding Glass	107
8	6'0" x 2'0" Sliding Glass	108
9	6'0" x 2'0" Sliding Glass	109
10	6'0" x 2'0" Sliding Glass	110
11	6'0" x 2'0" Sliding Glass	111
12	6'0" x 2'0" Sliding Glass	112
13	6'0" x 2'0" Sliding Glass	113
14	6'0" x 2'0" Sliding Glass	114
15	6'0" x 2'0" Sliding Glass	115
16	6'0" x 2'0" Sliding Glass	116
17	6'0" x 2'0" Sliding Glass	117
18	6'0" x 2'0" Sliding Glass	118
19	6'0" x 2'0" Sliding Glass	119
20	6'0" x 2'0" Sliding Glass	120

SAMPLE HOUSE PLANS
 phone: 123.456.7891
 sample.com

WINDOW SCHEDULE		
NO.	DESCRIPTION	MARK
1	3'0" x 4'0" Double Hung	201
2	3'0" x 4'0" Double Hung	202
3	3'0" x 4'0" Double Hung	203
4	3'0" x 4'0" Double Hung	204
5	3'0" x 4'0" Double Hung	205
6	3'0" x 4'0" Double Hung	206
7	3'0" x 4'0" Double Hung	207
8	3'0" x 4'0" Double Hung	208
9	3'0" x 4'0" Double Hung	209
10	3'0" x 4'0" Double Hung	210
11	3'0" x 4'0" Double Hung	211
12	3'0" x 4'0" Double Hung	212
13	3'0" x 4'0" Double Hung	213
14	3'0" x 4'0" Double Hung	214
15	3'0" x 4'0" Double Hung	215
16	3'0" x 4'0" Double Hung	216
17	3'0" x 4'0" Double Hung	217
18	3'0" x 4'0" Double Hung	218
19	3'0" x 4'0" Double Hung	219
20	3'0" x 4'0" Double Hung	220



NOT FOR CONSTRUCTION

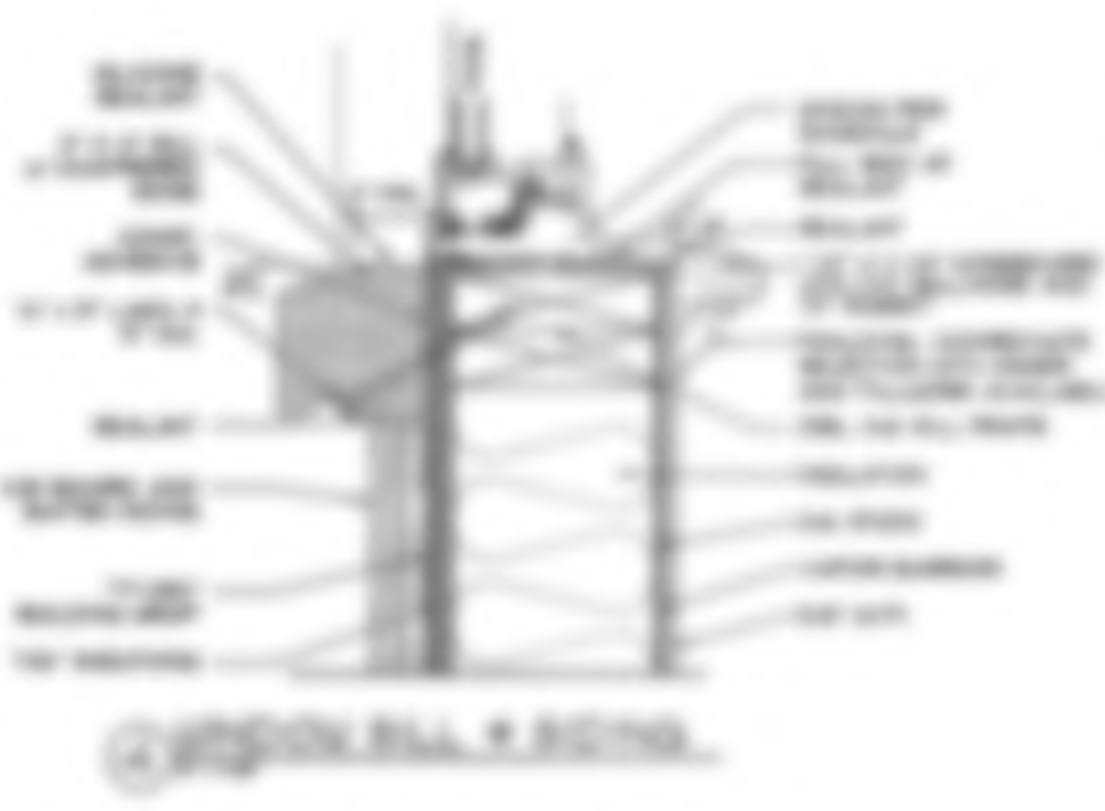
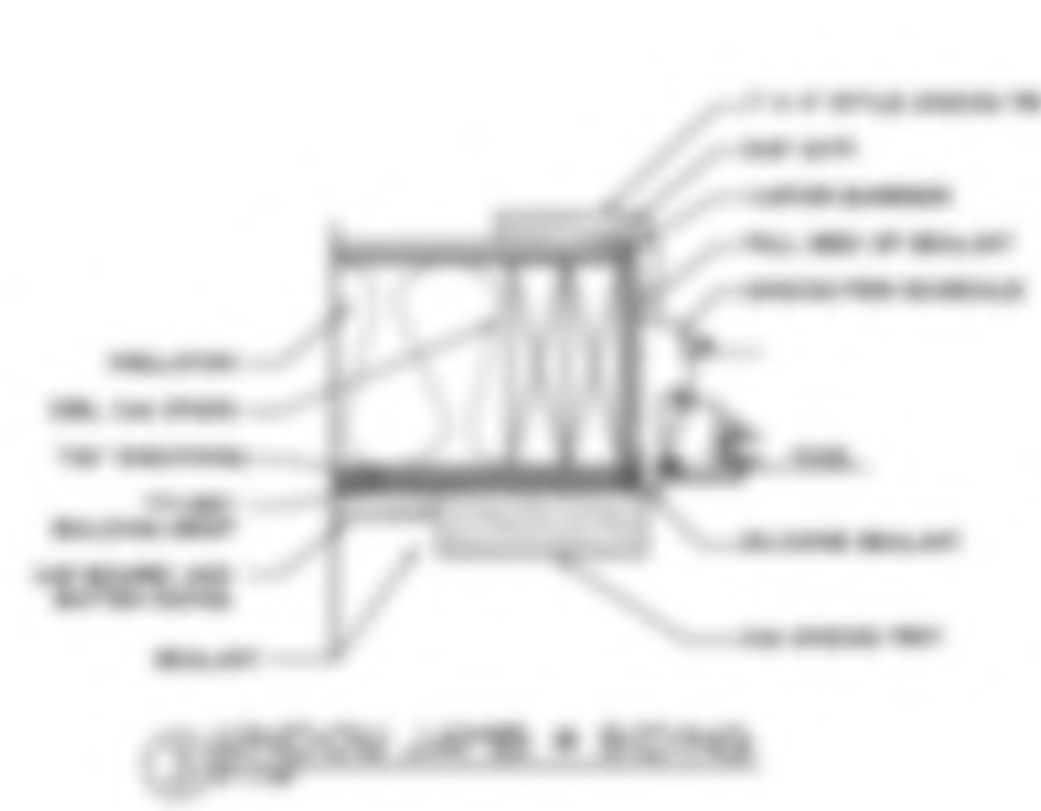
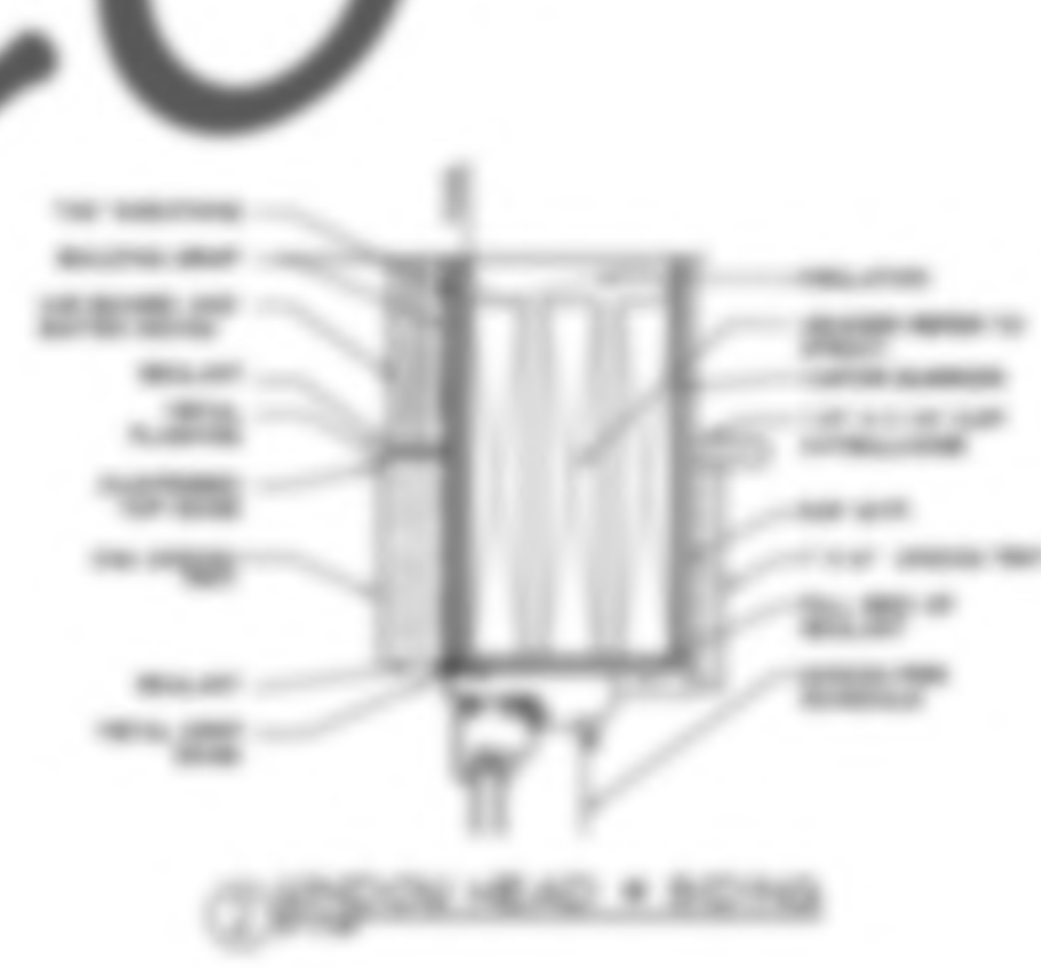

**DOOR/ WINDOW SCHEDULES
 DETAILS**
 SCALE 1/4" = 1'-0"

KEN PETER

SAMPLE HOUSE PLANS

phone: 1.23.456.7891

sample.com

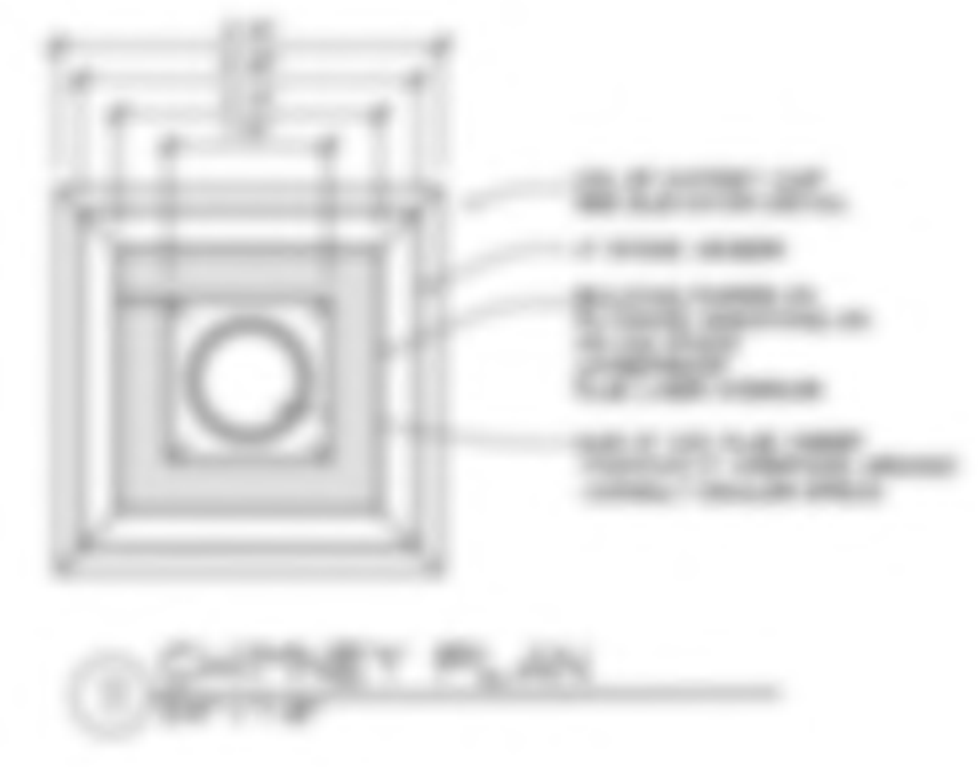
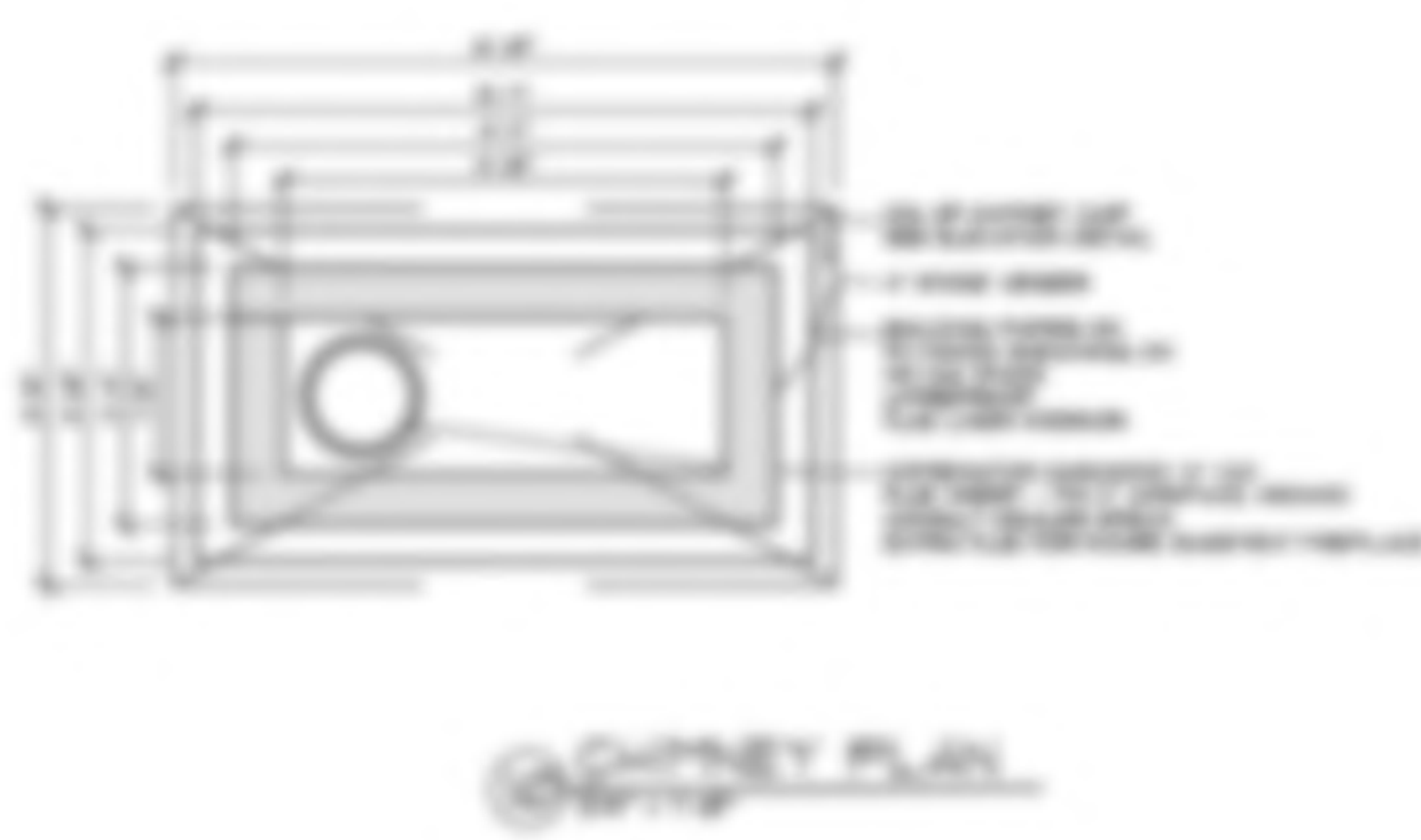
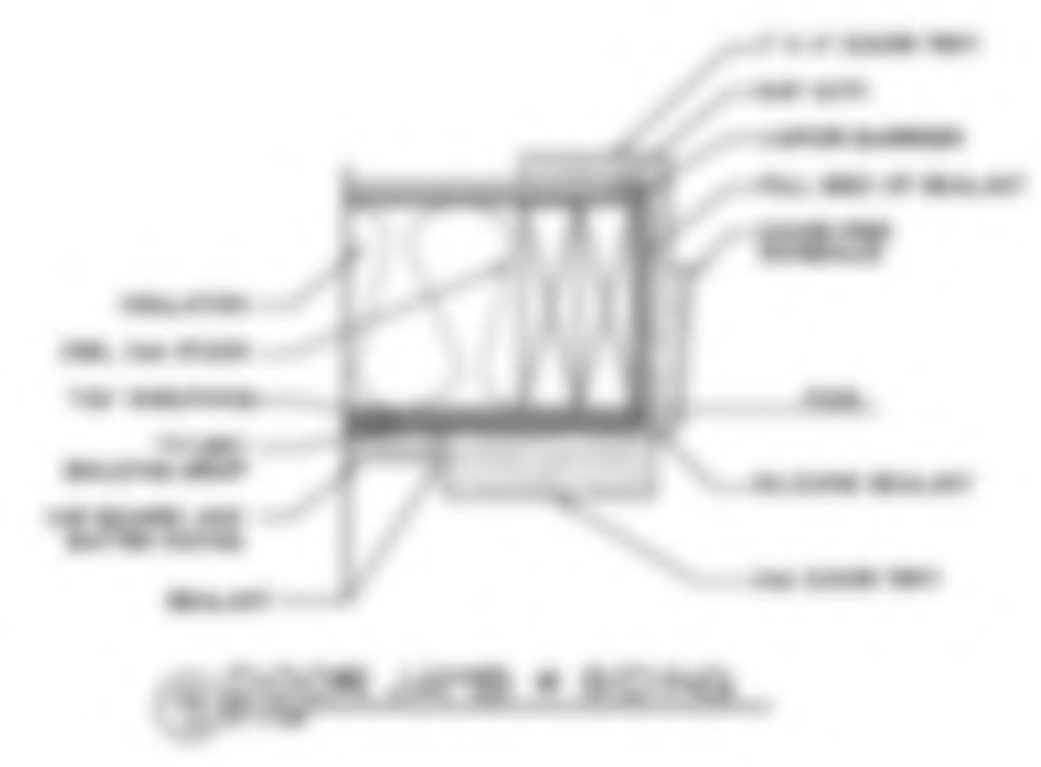
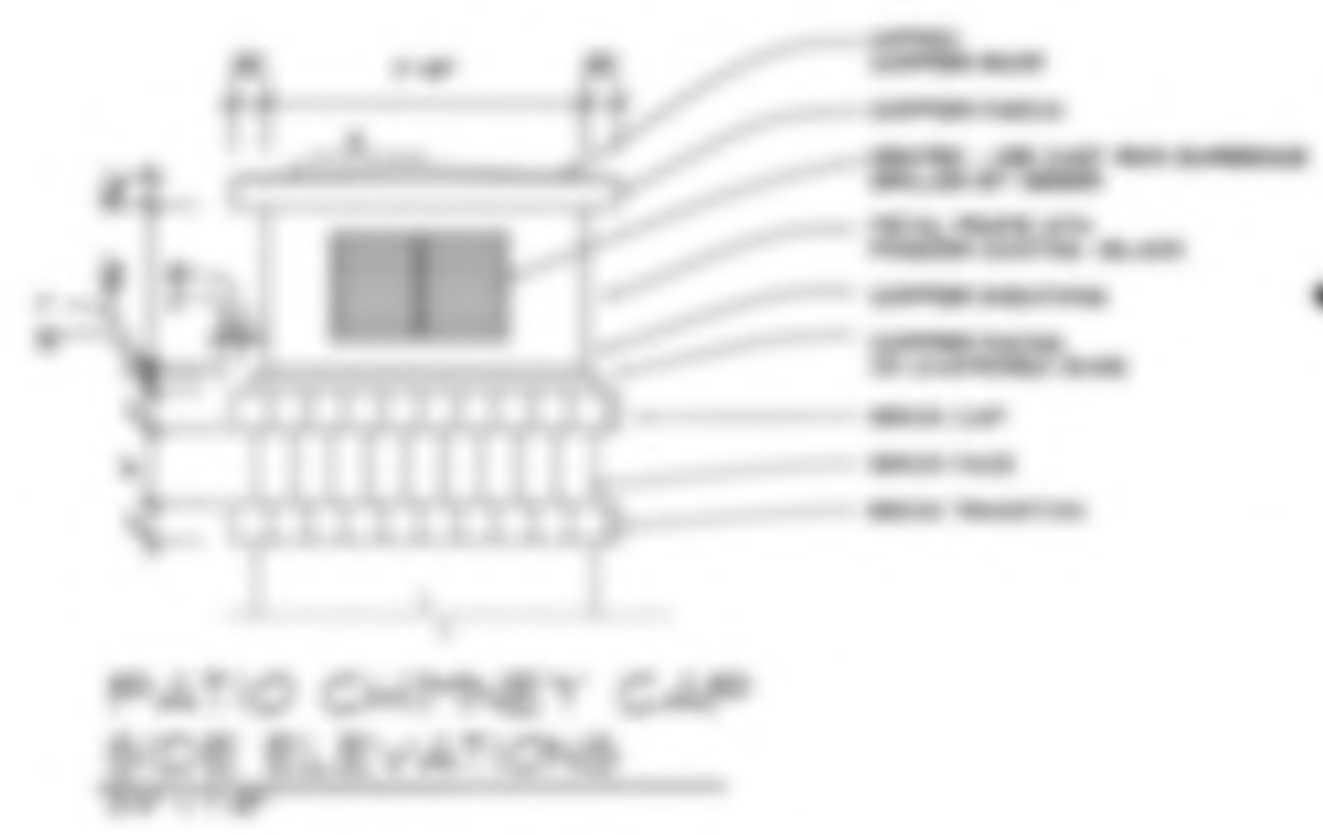
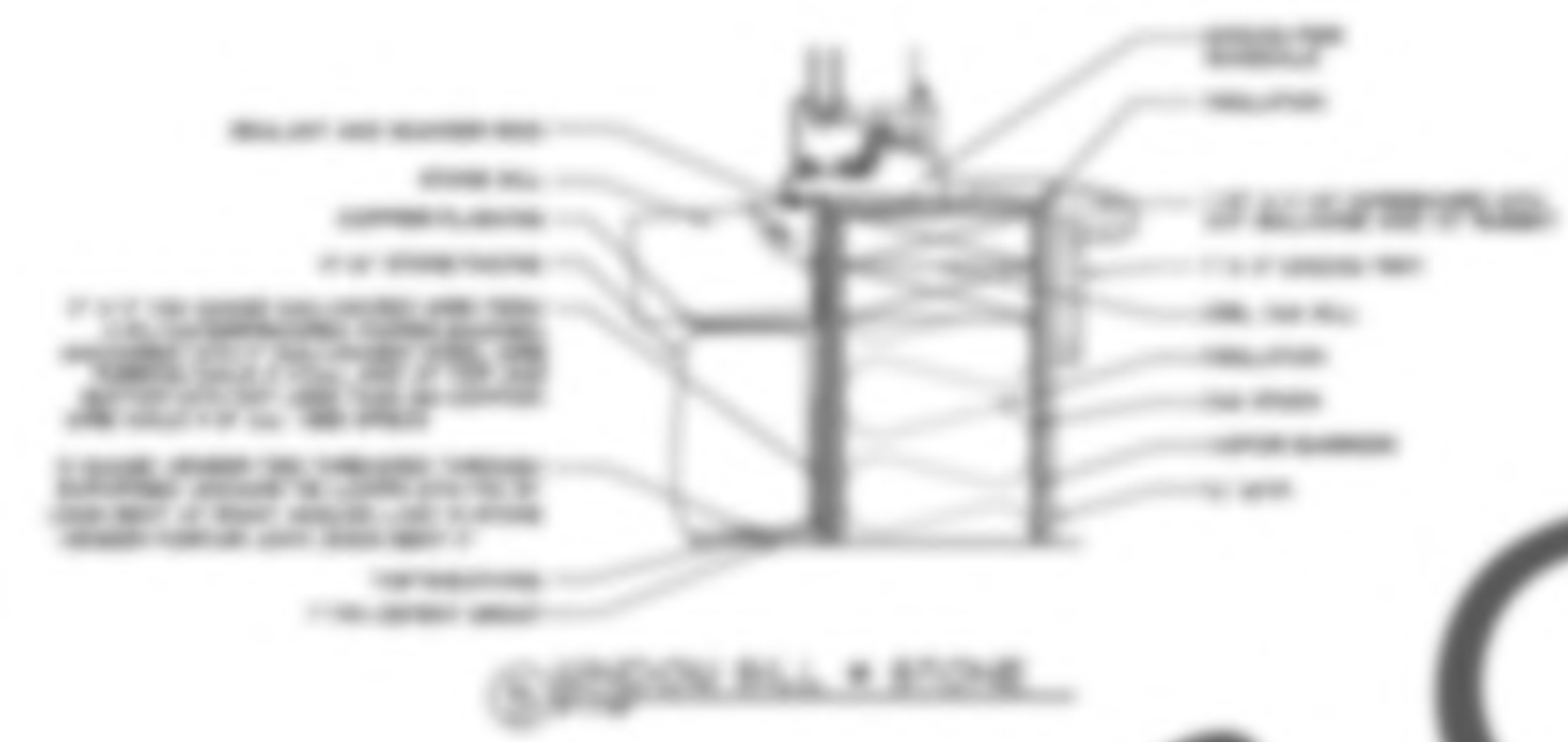
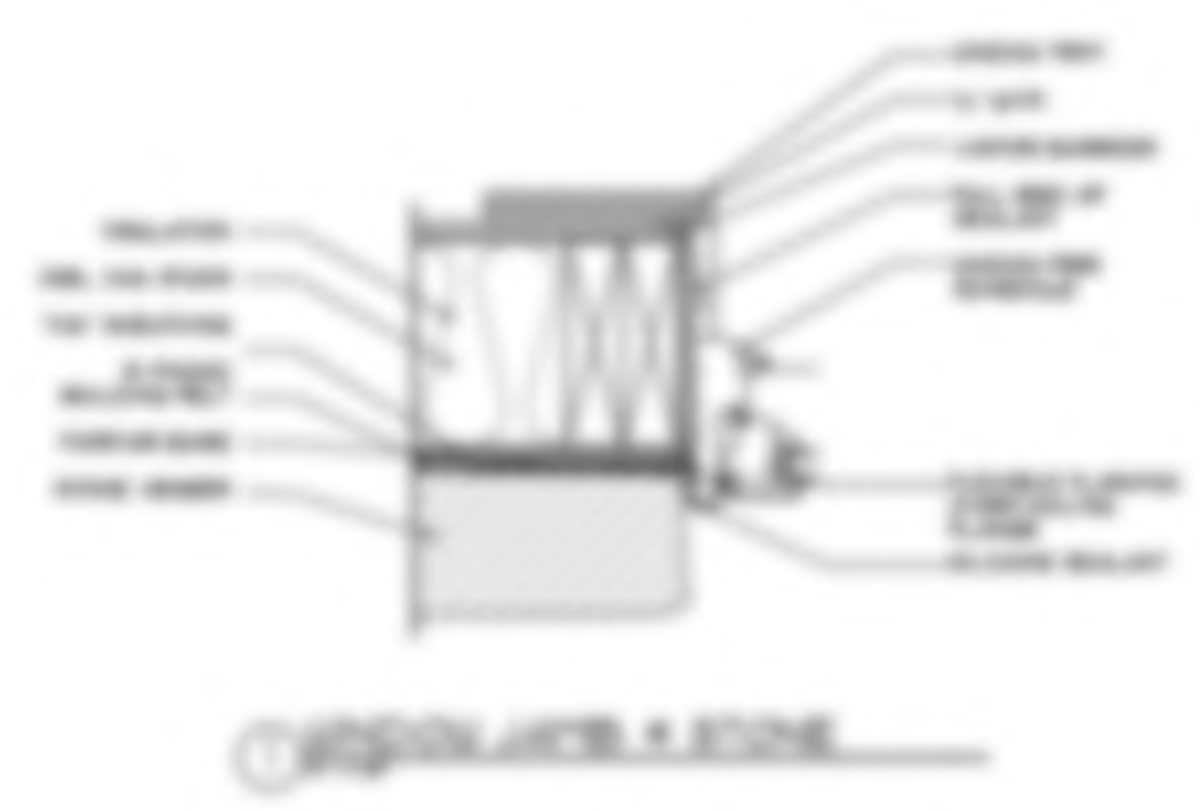

DETAILS

NOT FOR CONSTRUCTION

KEN PETER

SAMPLE PLAN

SAMPLE HOUSE PLANS

phone: 1 23.456.7891

sample.com



COVERED PORCH CEILING DETAIL



ENTRY DETAIL



BALUSTRADE AT WOOD FLOOR



EXTERIOR BALUSTRADE



ENTRY TIMBER FRAMING DETAIL

NOTE: THE DOOR AND WINDOW SCHEDULES IDENTIFY THE DOOR AND WINDOW

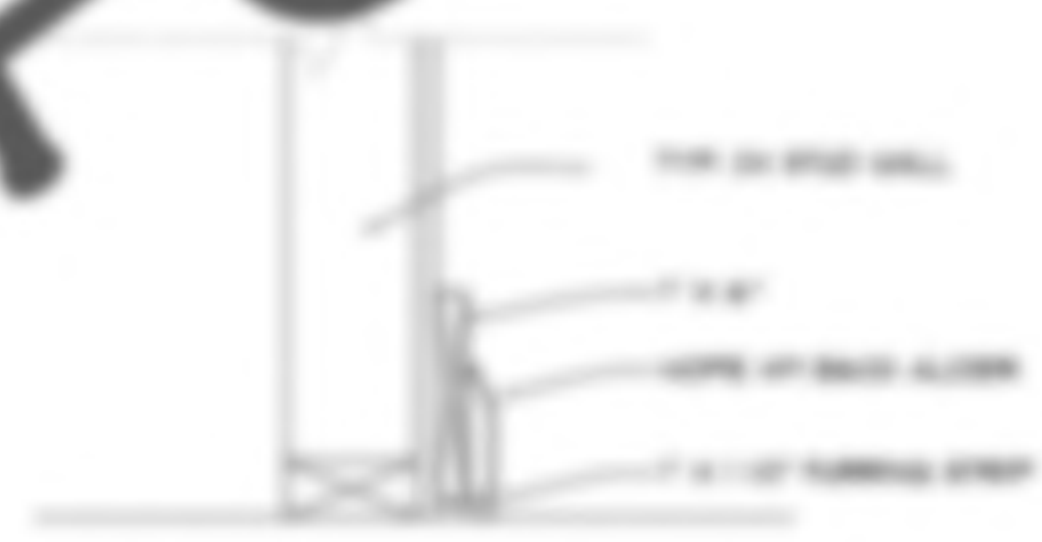

BALUSTRADE AT CARPET

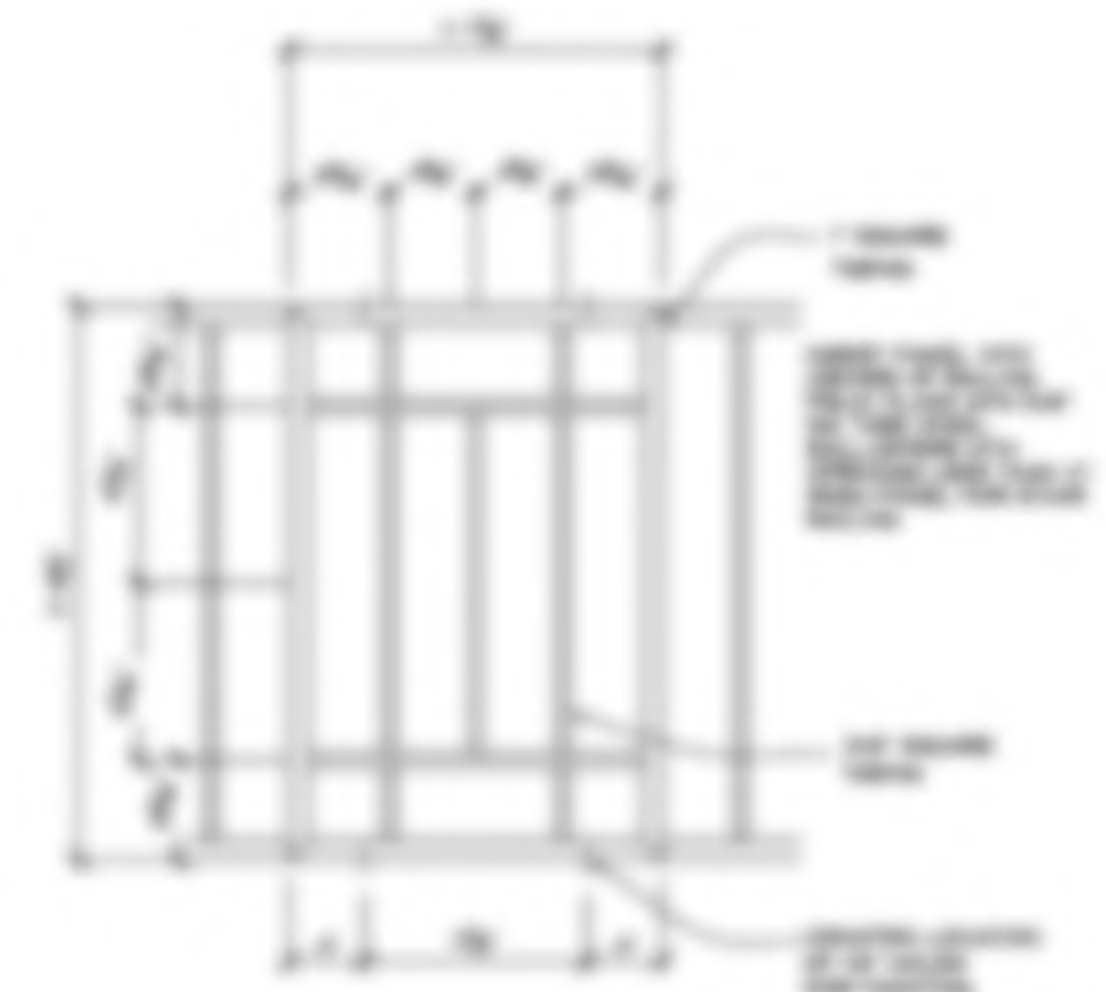

EXTERIOR BALUSTRADE

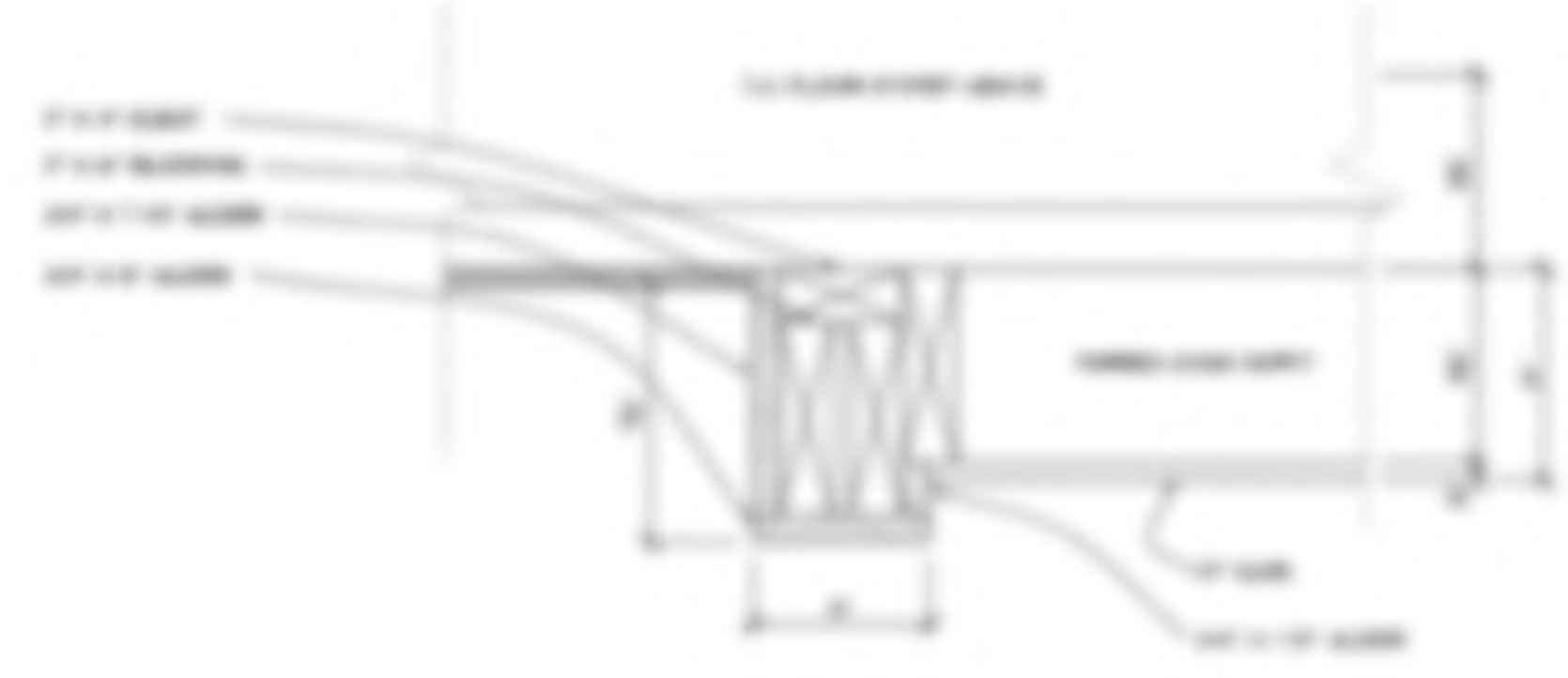

EXTERIOR TIMBER ACCENTS

NOT FOR CONSTRUCTION

SAMPLE HOUSE PLANS

phone: 123.456.7891

sample.com

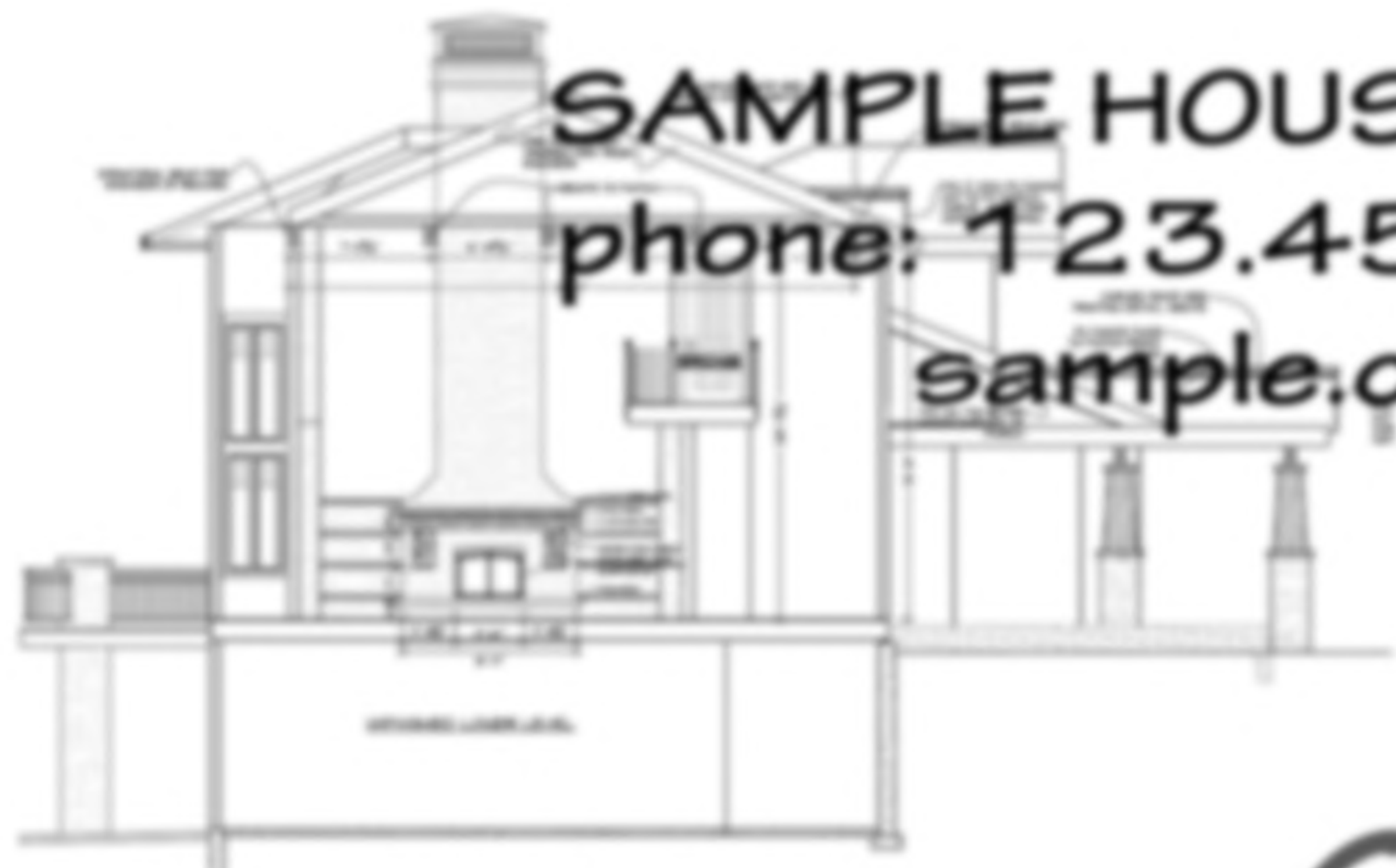

BUILDING SECTION A
SCALE 1/8" = 1'-0"



BUILDING SECTION B
SCALE 1/8" = 1'-0"



BUILDING SECTION C
SCALE 1/8" = 1'-0"

NOT FOR CONSTRUCTION

KEN PIERER

SAMPLE PLAN

SAMPLE HOUSE PLANS

phone: 123.456.7891

sample.com



BUILDING SECTION D
SCALE 1/8" = 1'-0"



BUILDING SECTION F
SCALE 1/8" = 1'-0"



BUILDING SECTION E
SCALE 1/8" = 1'-0"

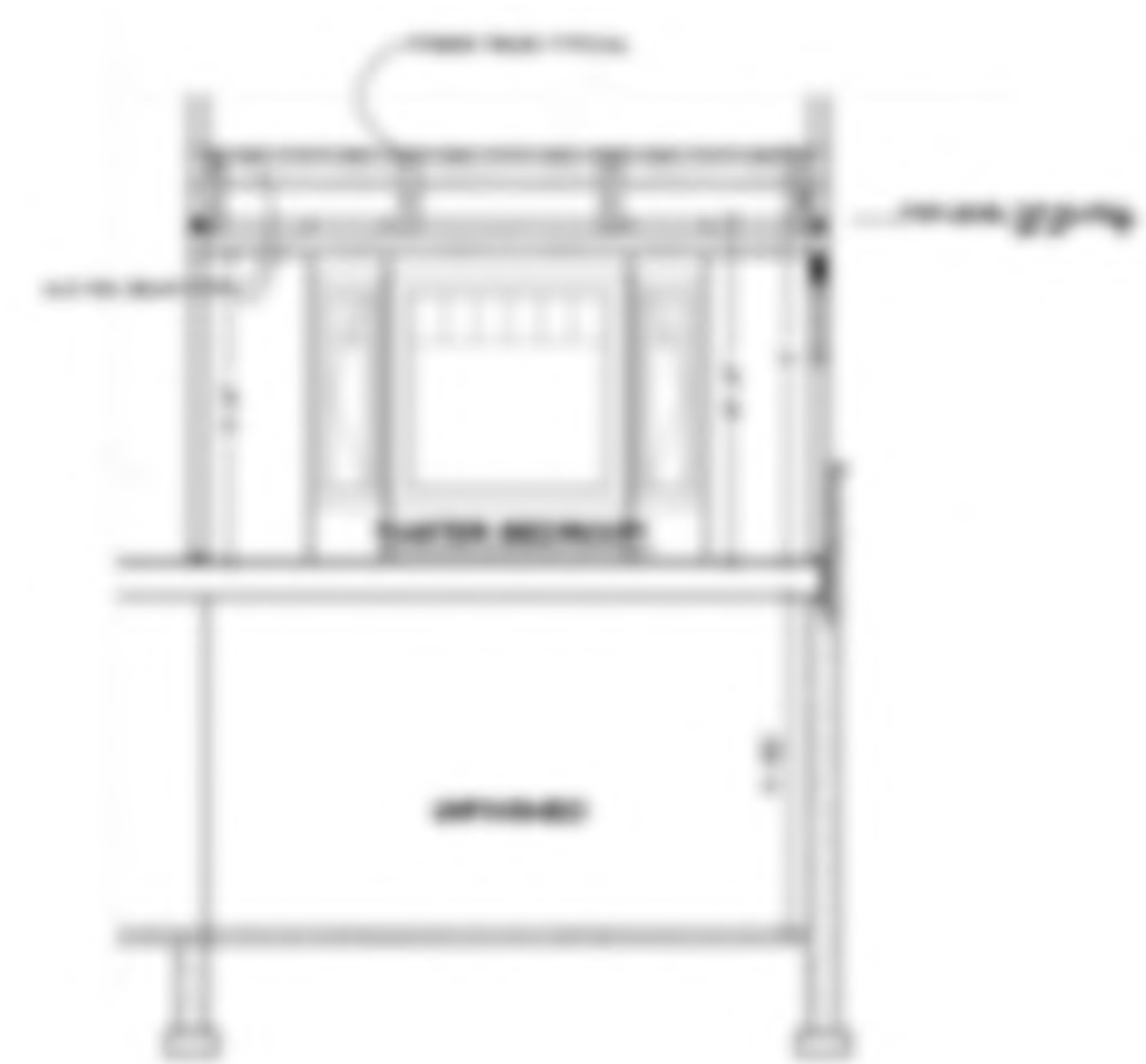

BUILDING SECTION H
SCALE 1/8" = 1'-0"

NOT FOR CONSTRUCTION

SAMPLE PLAN

KEN PIERER

SAMPLE HOUSE PLANS

phone: 123.456.7891

sample.com

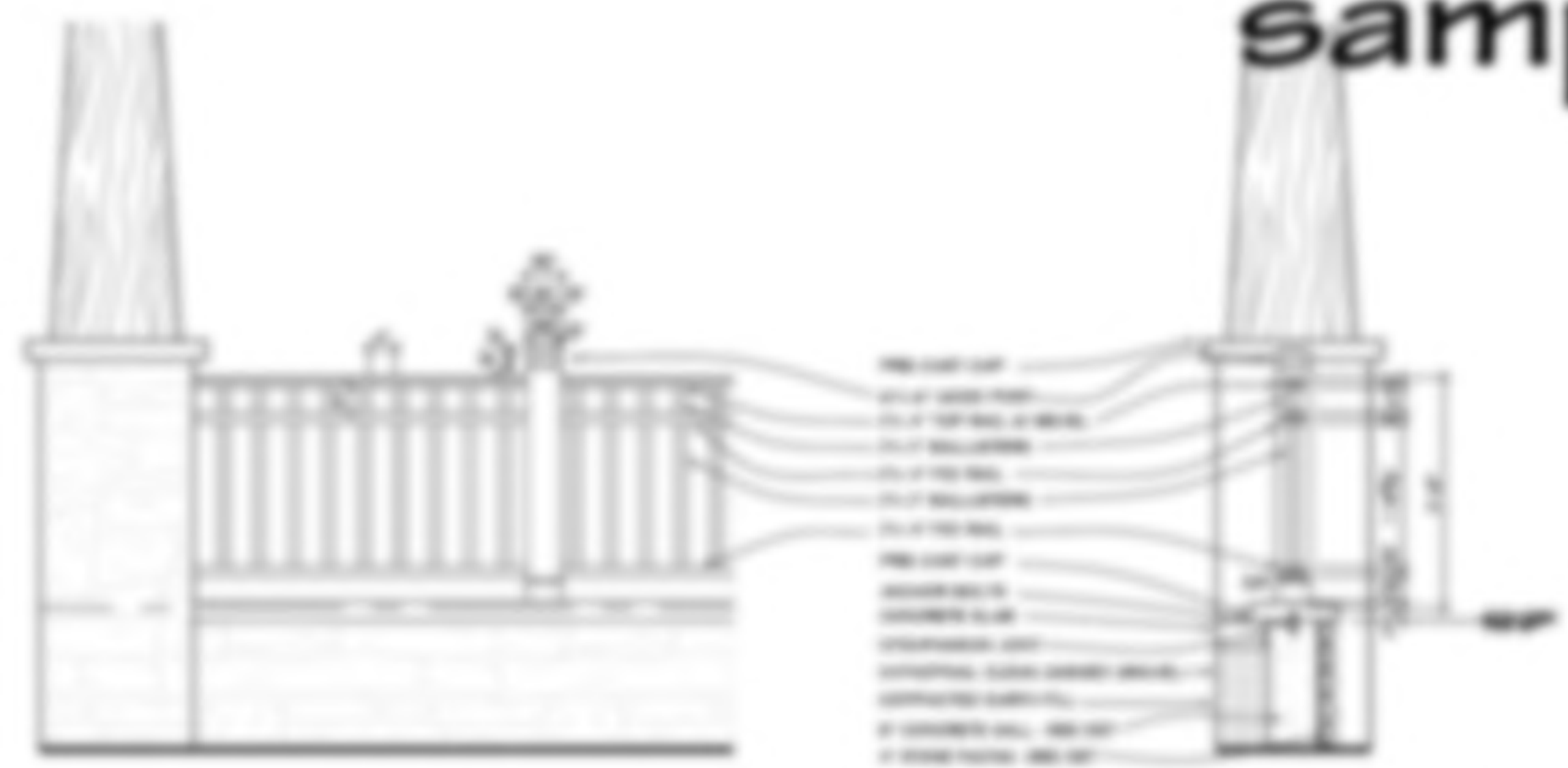

DETAIL • EXTERIOR GUARDRAIL
SCALE 3/4\"/>



COLUMN BASE SECTION

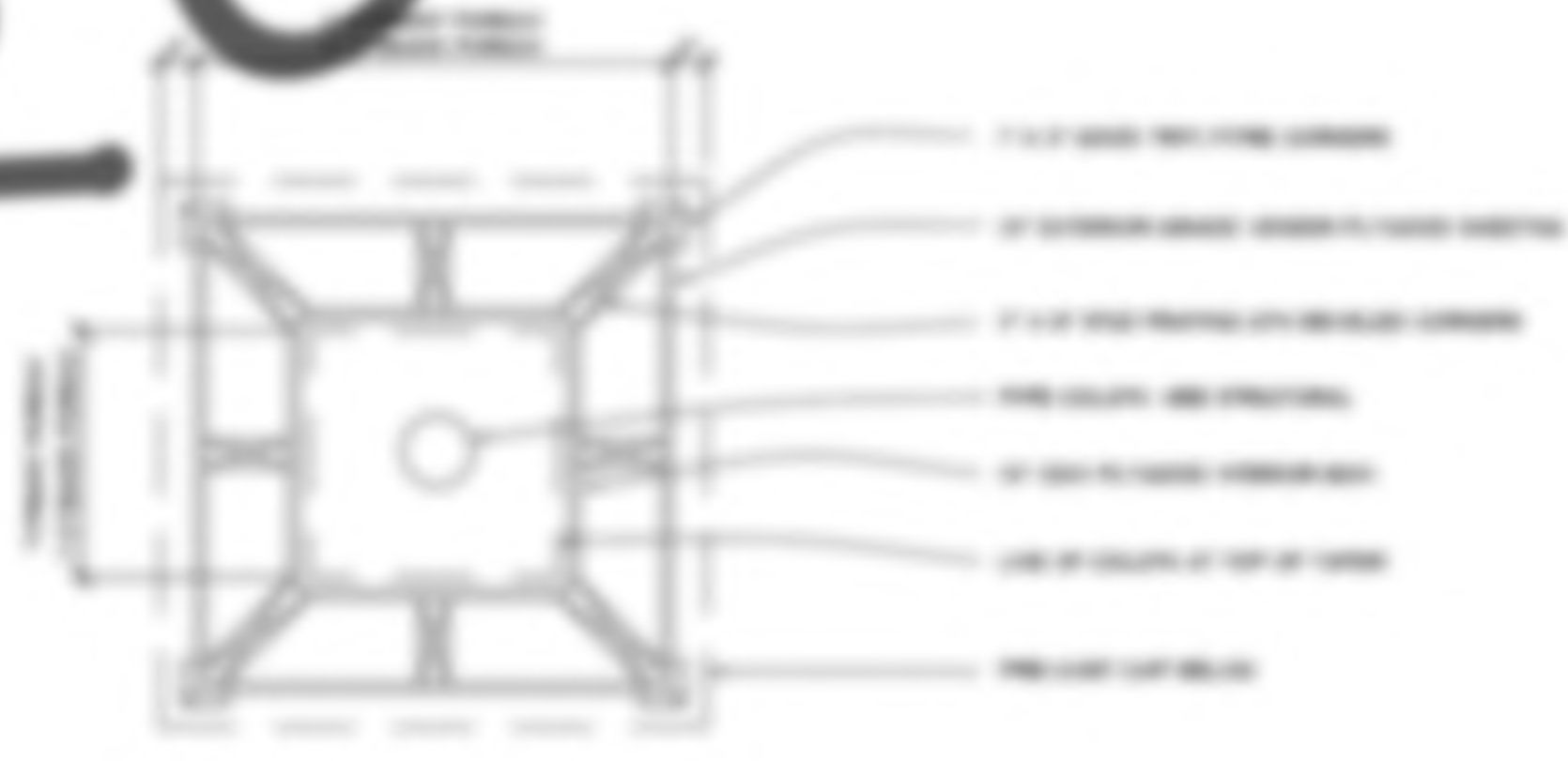

WOOD COLUMN PLAN



TYPICAL WALL SECTION
SCALE 1/2\"/>

NOT FOR CONSTRUCTION

SAMPLE HOUSE PLANS

phone: 123.456.7891

sample.com

NOT FOR CONSTRUCTION



UPPER LEVEL FLOOR PLAN

WALL LEGEND

[Symbol]	WALL
[Symbol]	DOOR
[Symbol]	WINDOW
[Symbol]	...

...



TOP OF TOWER DETAIL